

The RF Line

NPN Silicon

RF Power Transistor

Designed primarily for high-voltage applications as a high-power linear amplifier from 2.0 to 30 MHz. Ideal for marine and base station equipment.

- Specified 50 Volt, 30 MHz Characteristics
 - Output Power = 250 W
 - Minimum Gain = 12 dB
 - Efficiency = 45%
- Intermodulation Distortion @ 250 W (PEP) —
 - IMD = -30 dB (Max)
- 100% Tested for Load Mismatch at all Phase Angles with 3:1 VSWR

MRF448

**250 W, 30 MHz
RF POWER
TRANSISTOR
NPN SILICON**

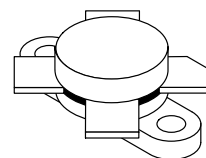

CASE 211-11, STYLE 1

MAXIMUM RATINGS

Rating	Symbol	Value	Unit
Collector-Emitter Voltage	V_{CEO}	50	Vdc
Collector-Base Voltage	V_{CBO}	100	Vdc
Emitter-Base Voltage	V_{EBO}	4.0	Vdc
Collector Current — Continuous	I_C	16	Adc
Withstand Current — 10 s	—	20	Adc
Total Device Dissipation @ $T_C = 25^\circ\text{C}$ (1) Derate above 25°C	P_D	290 1.67	Watts W/ $^\circ\text{C}$
Storage Temperature Range	T_{stg}	-65 to +150	$^\circ\text{C}$

THERMAL CHARACTERISTICS

Characteristic	Symbol	Max	Unit
Thermal Resistance, Junction to Case	$R_{\theta JC}$	0.6	$^\circ\text{C}/\text{W}$

ELECTRICAL CHARACTERISTICS ($T_C = 25^\circ\text{C}$ unless otherwise noted.)

Characteristic	Symbol	Min	Typ	Max	Unit
----------------	--------	-----	-----	-----	------

OFF CHARACTERISTICS

Collector-Emitter Breakdown Voltage ($I_C = 200$ mAdc, $I_B = 0$)	$V_{(BR)CEO}$	50	—	—	Vdc
Collector-Emitter Breakdown Voltage ($I_C = 100$ mAdc, $V_{BE} = 0$)	$V_{(BR)CES}$	100	—	—	Vdc
Collector-Base Breakdown Voltage ($I_C = 100$ mAdc, $I_E = 0$)	$V_{(BR)CBO}$	100	—	—	Vdc
Emitter-Base Breakdown Voltage ($I_E = 10$ mAdc, $I_C = 0$)	$V_{(BR)EBO}$	4.0	—	—	Vdc

NOTE:

- P_D is a measurement reflecting short term maximum condition. See SOAR curve for operating conditions.

(continued)

ELECTRICAL CHARACTERISTICS — continued ($T_C = 25^\circ\text{C}$ unless otherwise noted.)

Characteristic	Symbol	Min	Typ	Max	Unit
ON CHARACTERISTICS					
DC Current Gain ($I_C = 5.0 \text{ Adc}$, $V_{CE} = 10 \text{ Vdc}$)	h_{FE}	10	30	—	—
DYNAMIC CHARACTERISTICS					
Output Capacitance ($V_{CB} = 50 \text{ Vdc}$, $I_E = 0$, $f = 1.0 \text{ MHz}$)	C_{ob}	—	350	450	pF
FUNCTIONAL TESTS					
Common-Emitter Amplifier Power Gain ($V_{CC} = 50 \text{ Vdc}$, $P_{out} = 250 \text{ W CW}$, $f = 30 \text{ MHz}$, $I_{CQ} = 250 \text{ mA}$)	G_{PE}	12	14	—	dB
Collector Efficiency ($V_{CC} = 50 \text{ Vdc}$, $P_{out} = 250 \text{ W}$, $f = 30 \text{ MHz}$, $I_{CQ} = 250 \text{ mA}$)	η	—	45 65	—	% (PEP) % (CW)
Intermodulation Distortion (2) ($V_{CE} = 50 \text{ Vdc}$, $P_{out} = 250 \text{ W (PEP)}$, $I_{CQ} = 250 \text{ mA}$, $f = 30 \text{ MHz}$)	IMD	—	-33	-30	dB
Electrical Ruggedness ($V_{CC} = 50 \text{ Vdc}$, $P_{out} = 250 \text{ W CW}$, $f = 30 \text{ MHz}$, VSWR 3:1 at all Phase Angles)	ψ	No Degradation in Output Power			

NOTE:

2. To Mil-Std-1311 Version A, Test Method 2204, Two Tone, Reference each Tone.

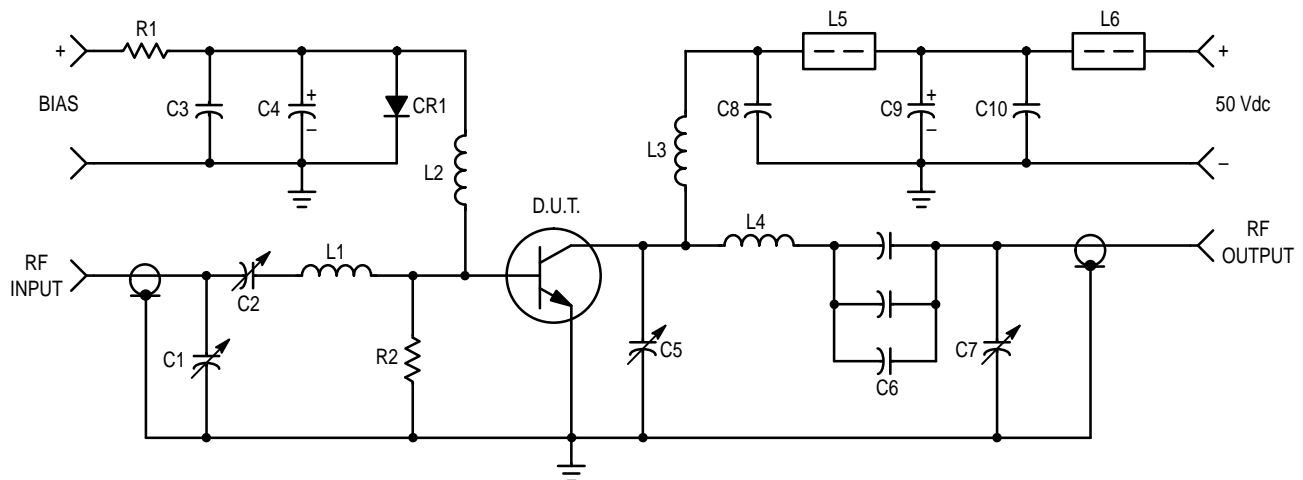

C1, C2, C5, C7 — 170–780 pF, Arco 469
 C3, C8, C9 — 0.1 μF , 100 V Erie
 C4 — 500 μF @ 6.0 V
 C6 — 360 pF, 3 x 120 pF 3.0 kV in parallel
 C10 — 10 μF , 100 V
 R1 — 10 Ω , 10 Watt
 R2 — 10 Ω , 1.0 Watt

CR1 — 1N4997 or equivalent
 L1 — 3 Turns, #16 Wire, 0.4" I.D., 0.3" Long
 L2 — 0.8 μH , Ohmite Z-235 or equivalent
 L3 — 12 Turns, #16 Enameled Wire Closewound 0.25" I.D.
 L4 — 4 Turns, 1/8" Copper Tubing, 0.6" I.D., 1.0" Long
 L5, L6 — 2.0 μH , Fair-Rite 2643021801 Ferrite bead each or equivalent

Figure 1. 30 MHz Test Circuit Schematic

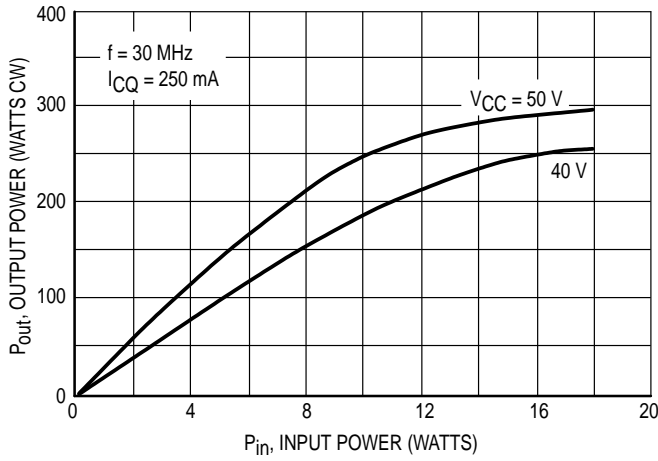

Figure 2. Output Power versus Input Power

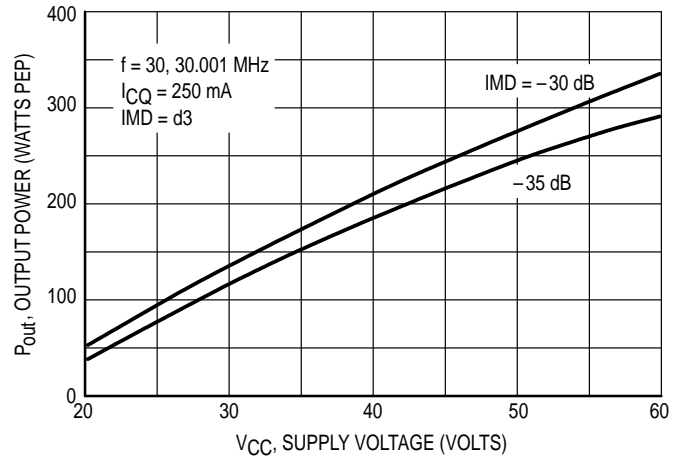

Figure 3. Output Power versus Supply Voltage

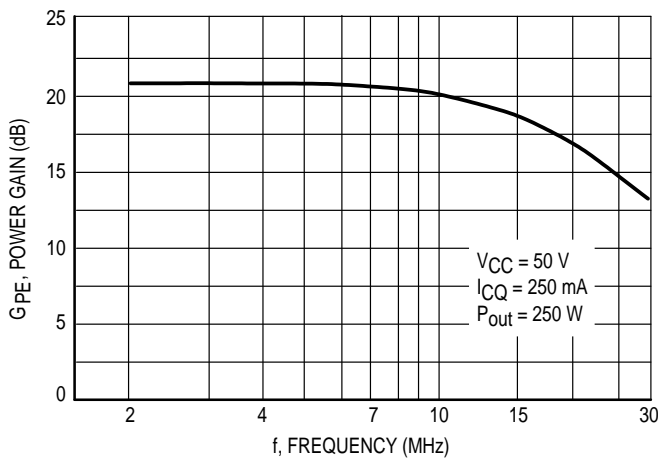

Figure 4. Power Gain versus Frequency

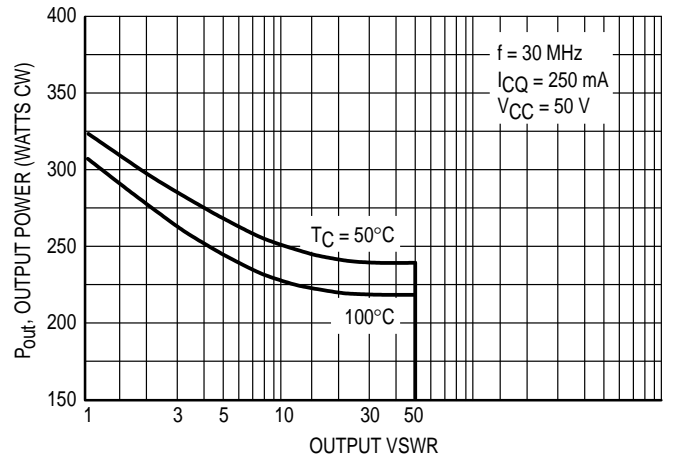

Figure 5. RF SOAR (Class AB) Pout versus Output VSWR

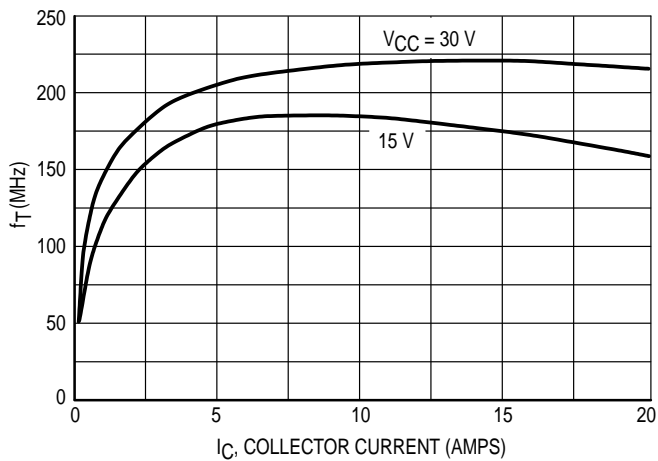

Figure 6. f_T versus Collector Current

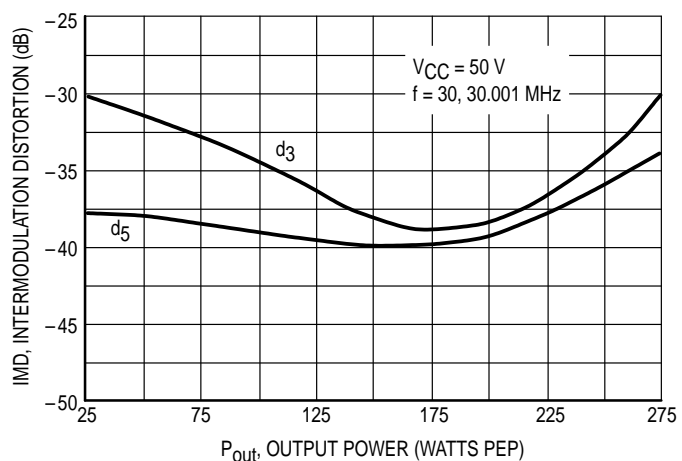

Figure 7. IMD versus Pout

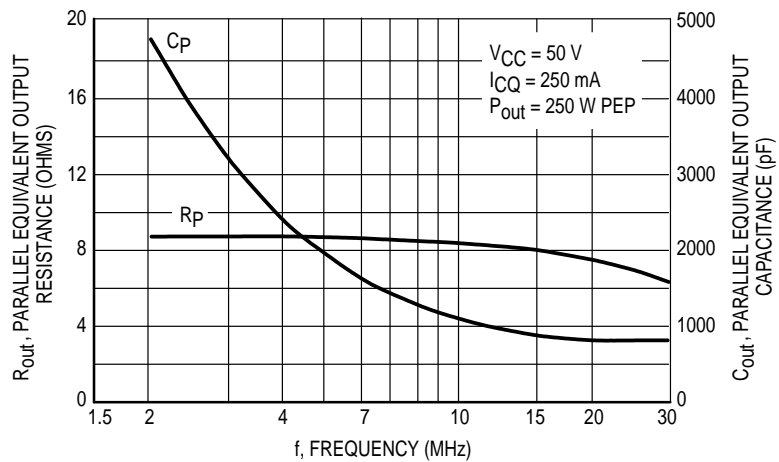

Figure 8. Output Resistance and Capacitance versus Frequency

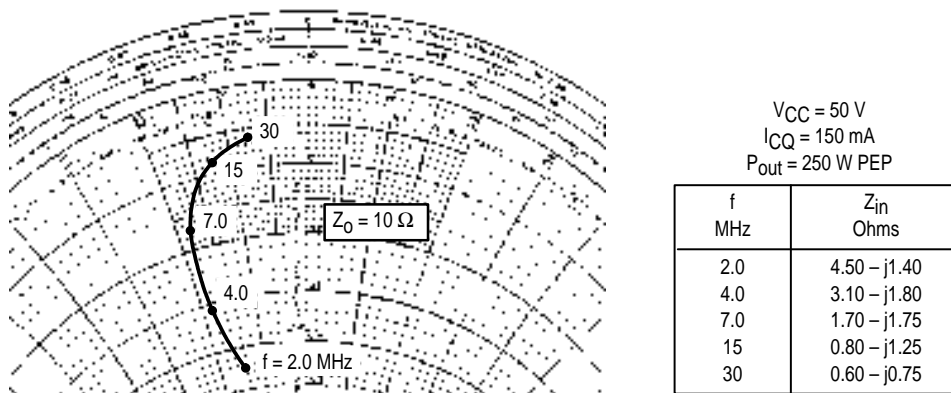
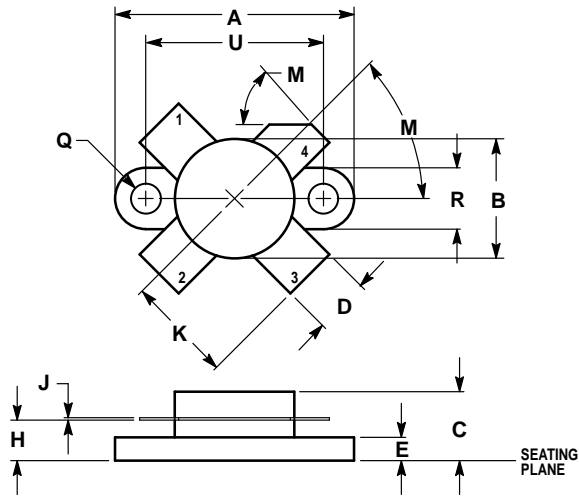

Figure 9. Series Equivalent Impedance

PACKAGE DIMENSIONS



- NOTES:
 1. DIMENSIONING AND TOLERANCING PER ANSI Y14.5M, 1982.
 2. CONTROLLING DIMENSION: INCH.

DIM	INCHES		MILLIMETERS	
	MIN	MAX	MIN	MAX
A	0.960	0.990	24.39	25.14
B	0.465	0.510	11.82	12.95
C	0.229	0.275	5.82	6.98
D	0.216	0.235	5.49	5.96
E	0.084	0.110	2.14	2.79
H	0.144	0.178	3.66	4.52
J	0.003	0.007	0.08	0.17
K	0.435	—	11.05	—
M	45°NOM		45°NOM	
Q	0.115	0.130	2.93	3.30
R	0.246	0.255	6.25	6.47
U	0.720	0.730	18.29	18.54

- STYLE 1:
 PIN 1. EMITTER
 2. BASE
 3. EMITTER
 4. COLLECTOR

**CASE 211-11
 ISSUE N**

Motorola reserves the right to make changes without further notice to any products herein. Motorola makes no warranty, representation or guarantee regarding the suitability of its products for any particular purpose, nor does Motorola assume any liability arising out of the application or use of any product or circuit, and specifically disclaims any and all liability, including without limitation consequential or incidental damages. "Typical" parameters can and do vary in different applications. All operating parameters, including "Typicals" must be validated for each customer application by customer's technical experts. Motorola does not convey any license under its patent rights nor the rights of others. Motorola products are not designed, intended, or authorized for use as components in systems intended for surgical implant into the body, or other applications intended to support or sustain life, or for any other application in which the failure of the Motorola product could create a situation where personal injury or death may occur. Should Buyer purchase or use Motorola products for any such unintended or unauthorized application, Buyer shall indemnify and hold Motorola and its officers, employees, subsidiaries, affiliates, and distributors harmless against all claims, costs, damages, and expenses, and reasonable attorney fees arising out of, directly or indirectly, any claim of personal injury or death associated with such unintended or unauthorized use, even if such claim alleges that Motorola was negligent regarding the design or manufacture of the part. Motorola and  are registered trademarks of Motorola, Inc. Motorola, Inc. is an Equal Opportunity/Affirmative Action Employer.

How to reach us:

USA / EUROPE: Motorola Literature Distribution;
P.O. Box 20912; Phoenix, Arizona 85036. 1-800-441-2447

JAPAN: Nippon Motorola Ltd.; Tatsumi-SPD-JLDC, Toshikatsu Otsuki,
6F Seibu-Butsuryu-Center, 3-14-2 Tatsumi Koto-Ku, Tokyo 135, Japan. 03-3521-8315

MFAX: RMFAX0@email.sps.mot.com - TOUCHTONE (602) 244-6609
INTERNET: <http://Design-NET.com>

HONG KONG: Motorola Semiconductors H.K. Ltd.; 8B Tai Ping Industrial Park,
51 Ting Kok Road, Tai Po, N.T., Hong Kong. 852-26629298



MRF448/D

